

CENTROIP SYNCHRO

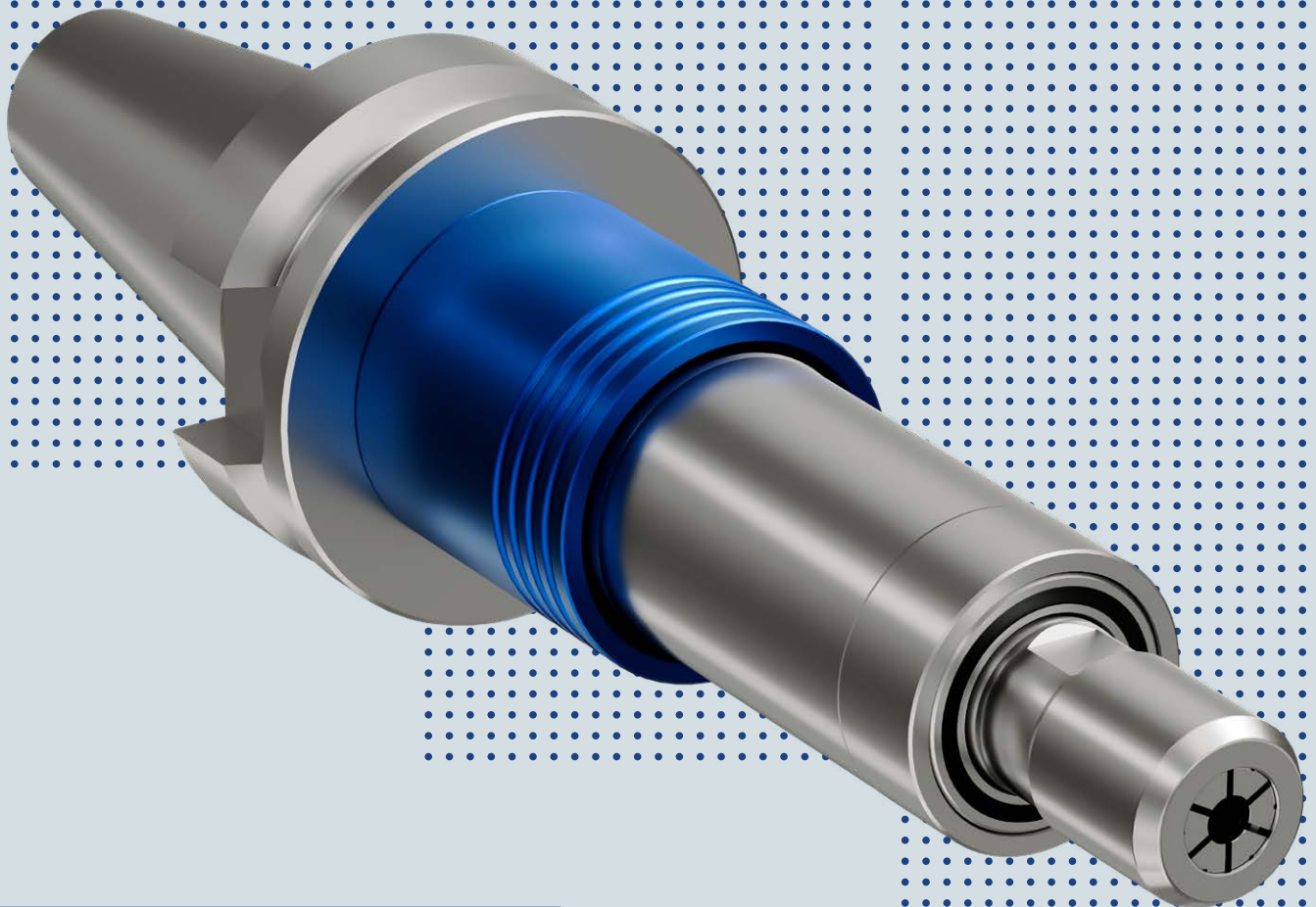

CENTROIP SYNCHRO
CHUCKS EAT UP
COMPRESSIVE FORCES.

This is synchronised thread
machining in perfection.

Decoupling without mechanical friction → Torque load without losing ease of movement

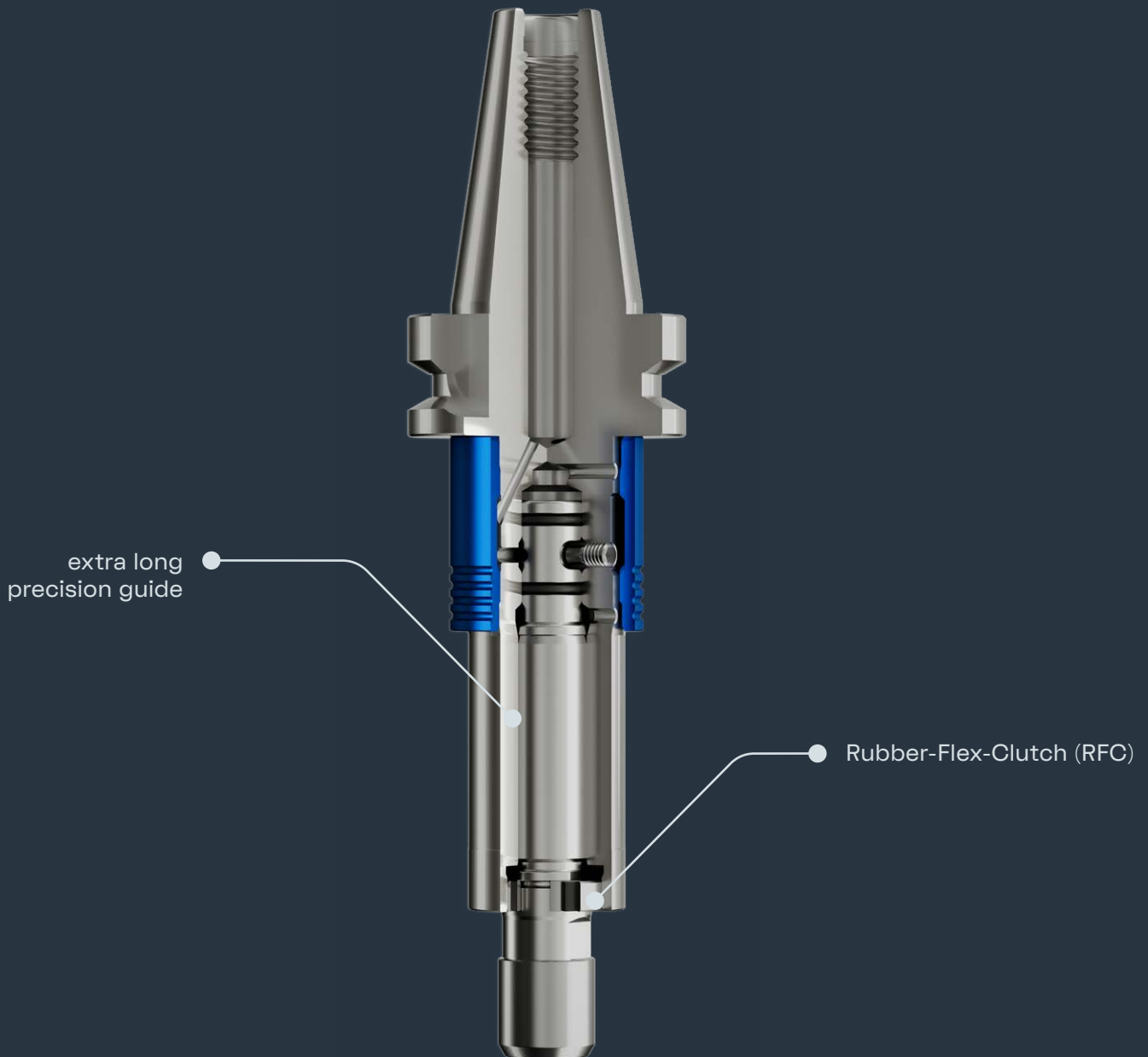

1

Secure process when
threading



2

Significantly longer
tool life

Features

1

Extremely low axial forces for low flank pressure and perfect surface quality.

2

Torsion damper and compensation mechanism in the circumferential direction.

3

Depth of up to 150 mm achievable with Ø10 interfering contour (for thread size M0.5 - M3).

4

Suitable for internal coolant supply of up to 80 bar.

5

Suitable for thread taps and forming taps.

6

Suitable for right-hand and left-hand threads.

7

Suitable for blind and through holes.

8

Minimum length compensation in push and pull direction.

9

Drastically reduces the flank pressure on old and new CNC machining centres.

Benefits

1

Even more stable! More secure processes thanks to smooth operation even under torque load.

2

Even more durable! Longer tool life of the tap and forming tap.

3

Even smaller! Significantly smaller outer diameter than previously available on the market.

4

Even more! 10 times more internal cooling directly on the tool than the best competitor (for ER8).

5

Even more precise! Twice the concentricity for the lowest flank pressure.

6

Even smoother! Damped reversal of direction of rotation for fewer tool breakages.

What a synchro chuck is capable of

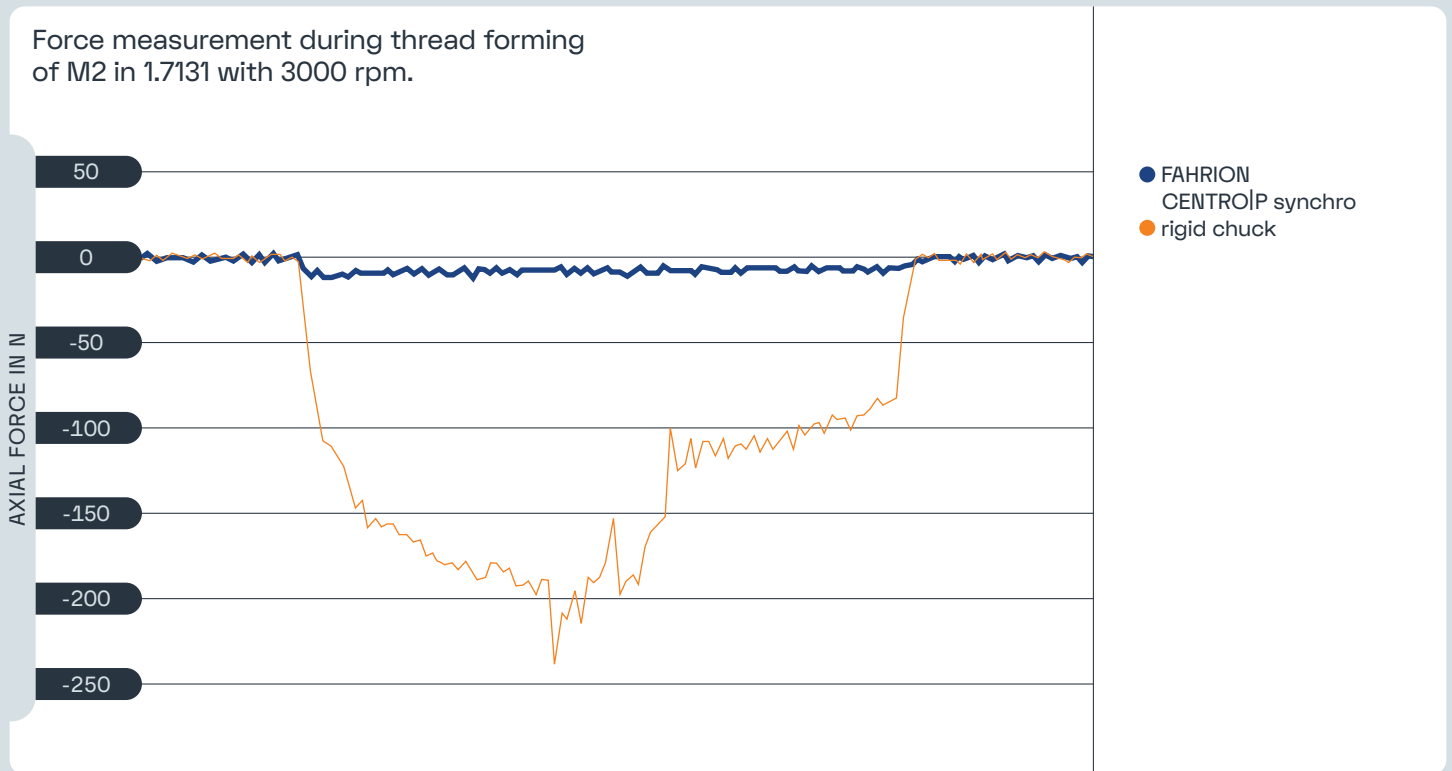

A tapping chuck with minimum length compensation (synchro chuck) compensates for any synchronisation errors that occur and keeps the forces acting on it in check. In order to produce threads reliably, it is crucial that the synchro chuck can maintain its ease of movement, especially under torque load.

The axial forces generated during thread machining can be clearly seen in the diagram: Machining with a rigid chuck (orange line) compared with a chuck including synchronised compensation (blue line).



The general rule is:
The weaker the axial force,
the better the quality, lower
the wear, longer the tool life,
safer the process.

What makes CENTRO|P synchro so unique

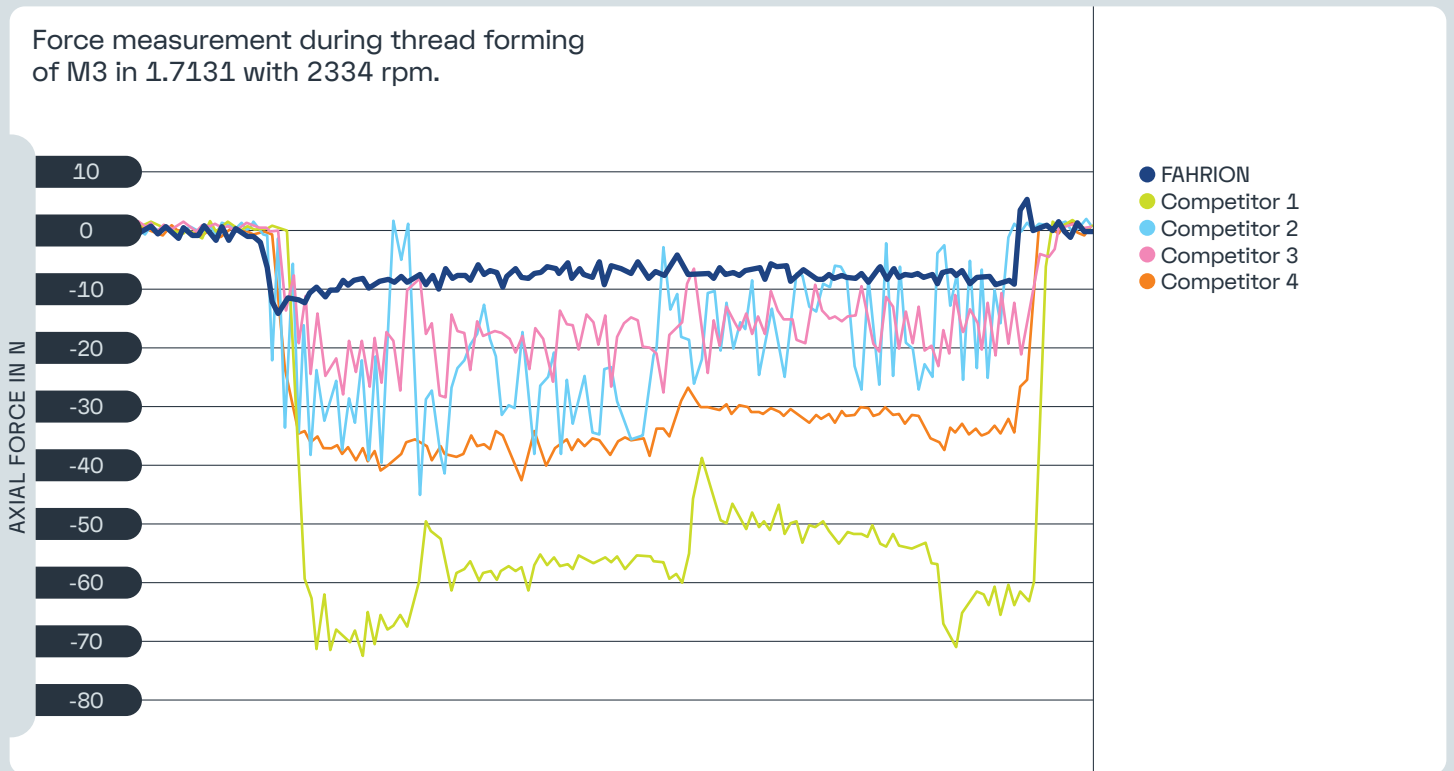

Every mechanical engineer knows: "When turning and pulling at the same time, you get a jam." This is an ongoing basic problem caused by balls, pins or similar drivers under torque load. FAHRION technology simply dispenses with such mechanical positive-locking drivers and instead works with our patent-pending clutch ("Rubber-Flex-Clutch").

The "Rubber-Flex-Clutch" (RFC) allows the tool holder to absorb torque loads without mechanical positive locking. The process of driving and equalisation takes place "in one piece" and is almost frictionless. In addition, the RFC ensures a damped momentum when the direction of rotation is reversed.



The diagram shows 4 chucks with different mechanical synchronised balancers, which we have compared with our RFC technology.



It can be clearly seen that our tapping chuck exhibits the lowest wear-promoting axial forces (dark blue line).

From synchronised compensation in four directions to backlash-free synchronised compensation

Pull and torsional force during thread cutting or forming

→ The RFC acts on the radial drive in the direction of rotation as well as on the axial compensation in both the tensile and compressive directions.

Push and torsional force after reversing the direction of rotation

→ The RFC acts on the radial drive in the reverse direction of rotation as well as on the axial compensation in both the tensile and compressive directions.

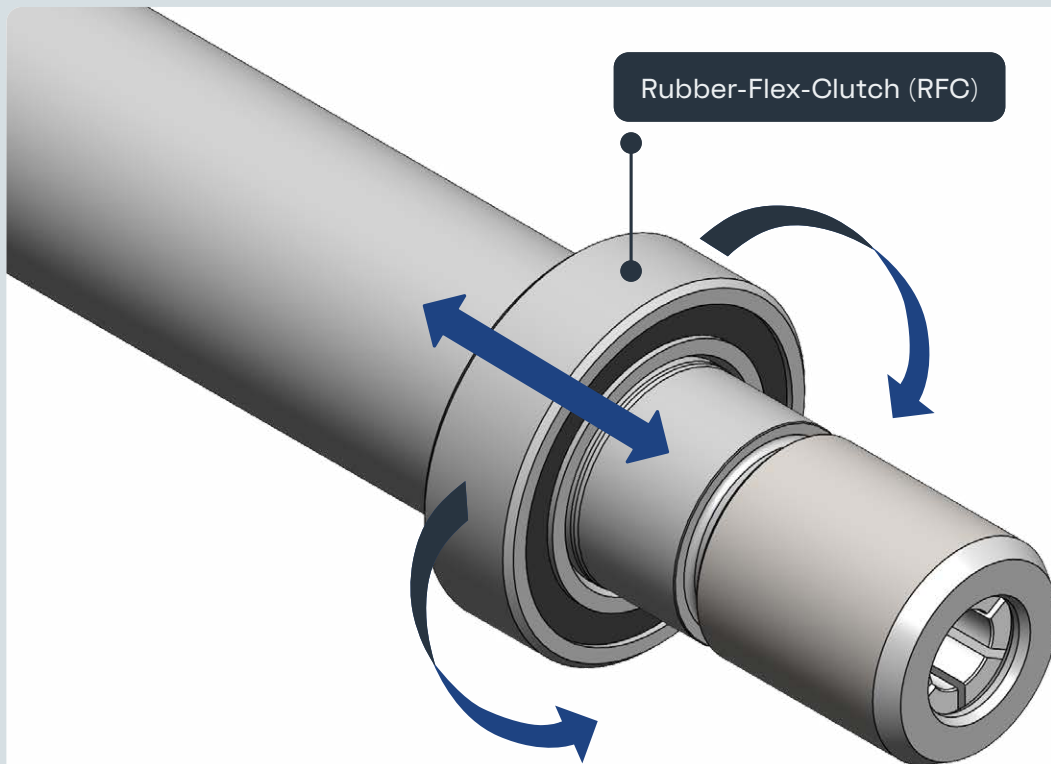

CENTRO|P synchro chucks are characterised by particularly long and precise guidance of the shaft with consistently high FAHRION quality.

What influence does the supply of cooling lubricant have on the threading process?

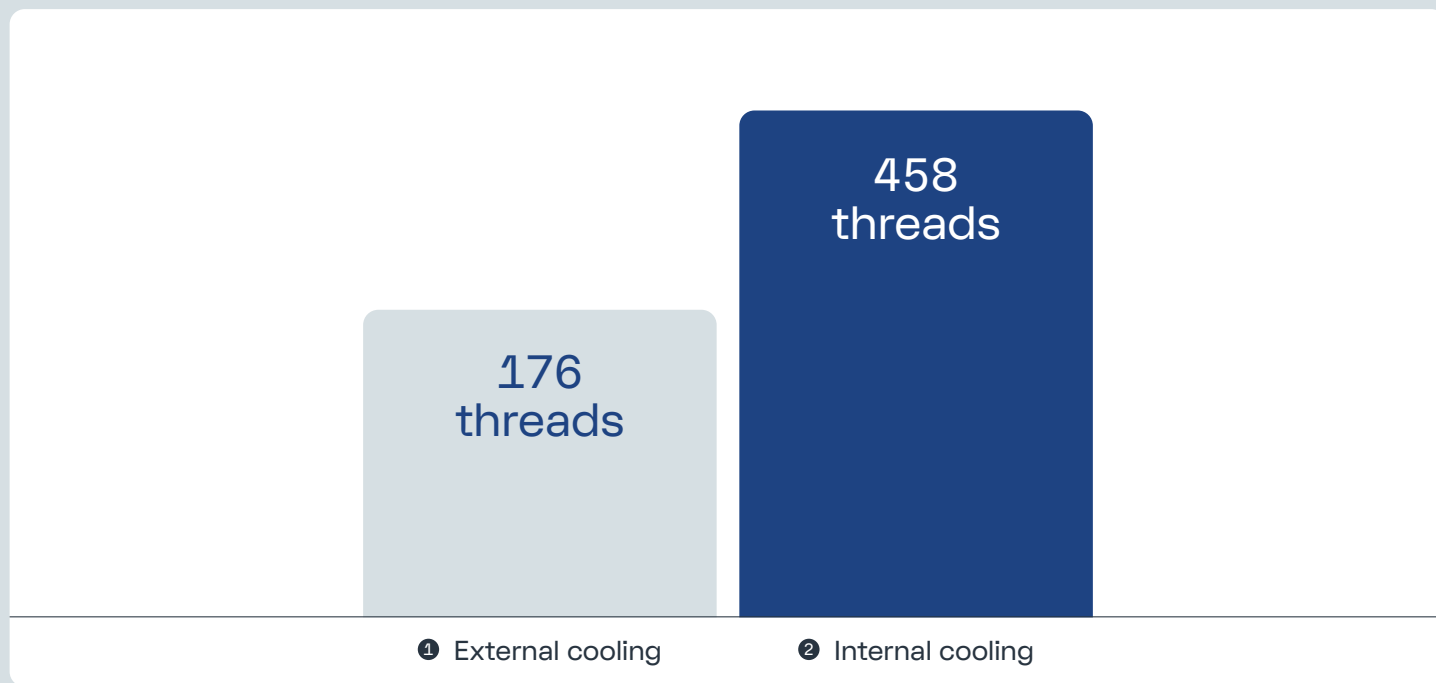

In several tool life tests, we have determined the average service life of the threading tool with different methods of cooling lubricant supply:

- 1 External cooling by coolant nozzles
- 2 Internal cooling through the tap/thread former

The result paints a clear picture:

When cooling from the outside, not enough coolant reaches the cutting edge, which leads to a poor service life of the threading tool.

In this test, the external cooling was optimally aligned with the cutting edge. In practice, this ideal alignment of the coolant nozzles is almost impossible to achieve and, above all, to maintain.

Internal cooling, whether through the collet or through the tool, proved to be optimal. Here, a sufficient and even amount of coolant is always applied to the cutting edge. Time-consuming adjustment and readjustment are completely unnecessary here.



The cooling lubricant supply has a very large influence on the process. The internal cooling lubricant supply massively increases tool life.



Regardless of whether tools with or without an internal cooling channel are used, the FAHRION HPD/HPDD or GBD/GBDD collet (see pages 16-21) achieves an optimal coolant supply.

Is an optimal coolant supply possible with all synchro chucks?

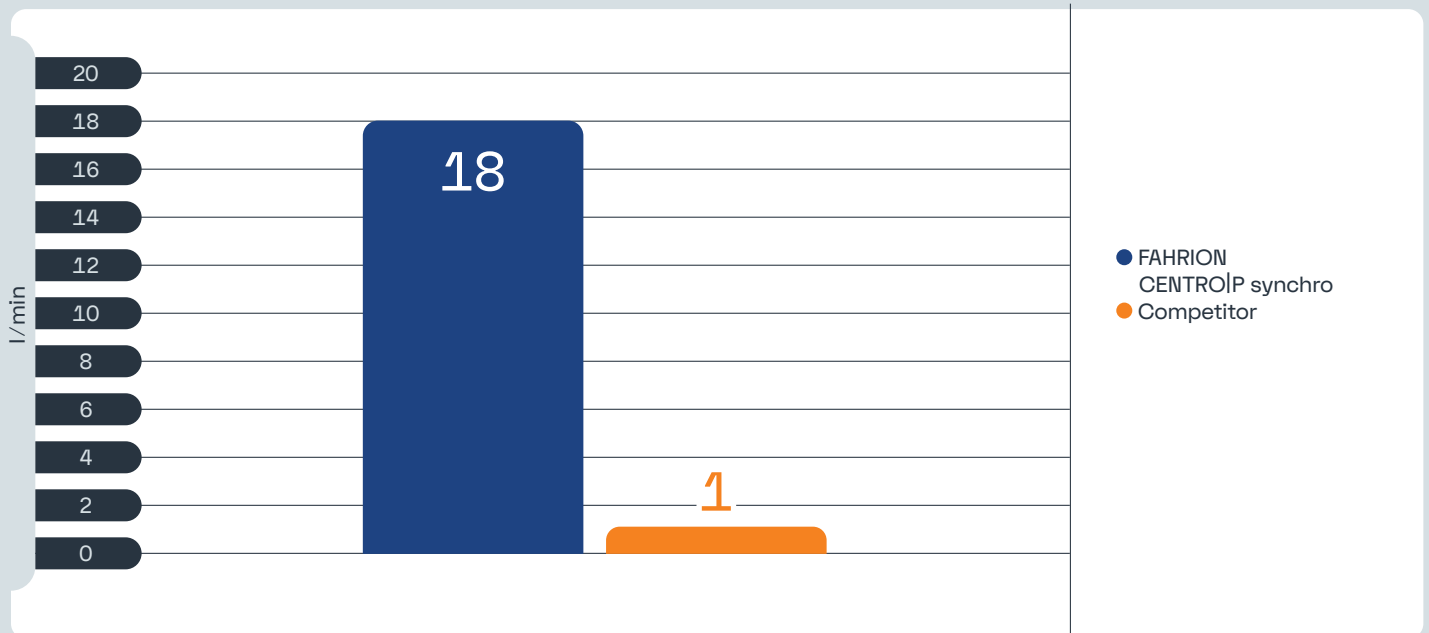

With a synchro chuck, the coolant cannot simply be fed through as with a standard chuck but must inevitably flow through several parts. This results in significant differences in the flow rates.

The optimised arrangement and the large cross-section of the channels in our CENTRO|P synchro clearly pay off here. With the MSC8 chuck body, we achieved 18 times the flow rate compared to the best competitor product with axial force neutral internal cooling (see following page).



Optimal cooling lubrication cannot be achieved with all synchro chucks. The flow rates differ many times over.



The synchro chucks from FAHRION achieve the highest flow rate of comparable chucks available on the market.

Is the functionality of the synchro chuck influenced by the internal cooling?

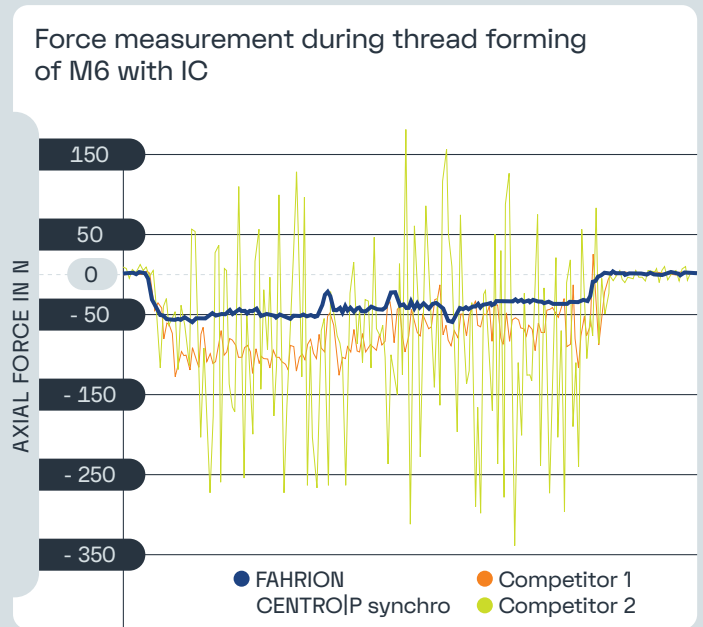
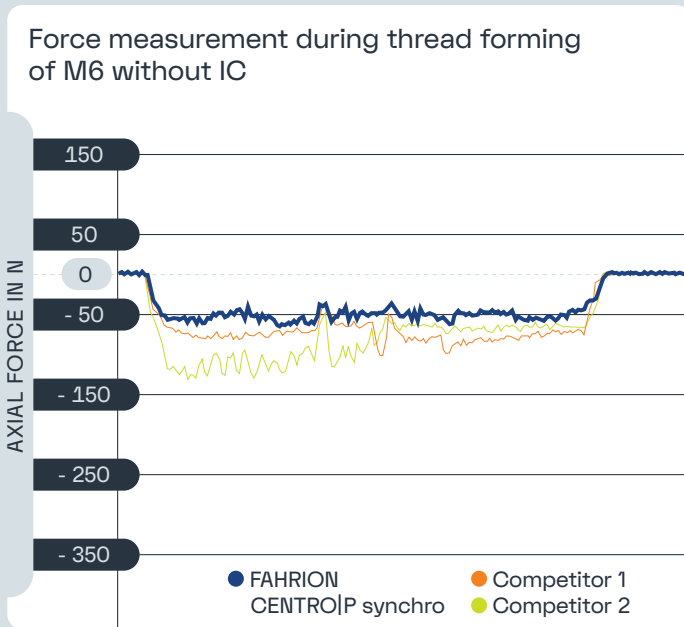

Force measurement when thread forming an M6 thread with a synchro chuck with the internal cooling lubricant supply switched off.

Force measurement during thread forming of an M6 thread with synchro chuck with internal cooling lubricant supply switched on.

All 3 synchro chucks show the typical force curve when forming a thread. The forces occurring with the CENTRO|P synchro are the lowest.

For one of the two competitors in particular, the curve deviates significantly from the curve in the left-hand diagram (green line). In this case, the function of the synchronised compensation and therefore a reliable process is no longer guaranteed. In contrast, the CENTRO|P synchro is equipped with an axial force neutral internal cooling system. The curve is comparable to the curve in the diagram on the left and therefore shows no influence of the cooling lubricant pressure.



Without axial force neutral cooling, the higher the pressure, the worse the synchronisation.



Thanks to the axial force neutral guidance of the coolant channels in the CENTRO|P synchro, the functionality and sensitivity of the Rubber-Flex-Clutch are optimised even at high coolant pressure.

Precise and synchronised down to the last corner ...

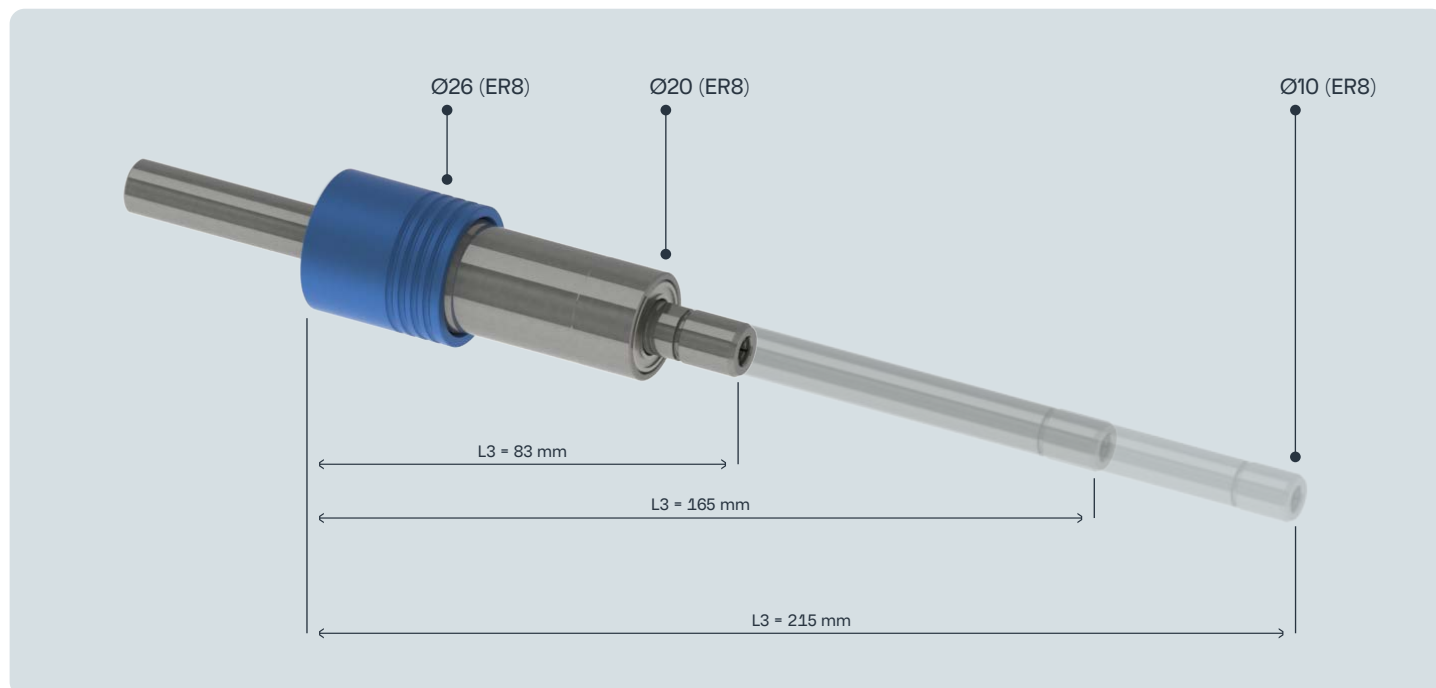

The FAHRION-specific design of the guideways ensures maximum concentricity even with long overhangs. The Rubber-Flex-Clutch (RFC) provides the necessary damping properties in the axial and radial directions. Our Mini Synchro Chuck MSC8 only requires a diameter of 10 mm on the clamping nut.

Additional cost savings: You only need the Mini Synchro Chuck (MSC) in the desired, longer version + cheaper taps in the standard length. Expensive taps are no longer required in the longer version.

... and with optimal cooling, too.



A unique feature is that the extended CENTRO|P synchro versions have an internal supply of cooling lubricant despite their extremely slim outer contour.

As shown schematically in the pictures, this internal coolant supply ensures that there is always enough coolant directly at the cutting edge, even with critical contours. The coolant can be discharged either through the tool and/or through the collet chuck.

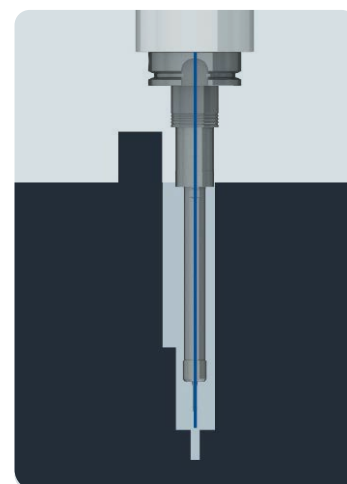

Success-Stories

Increase of tool life: 30% increase for M3 threads

Machine interface	MAS-BT 30
Material	1.0503 / C45
Thread size	M3 x 0.5
Core hole	D = 2.53 mm L = 10.0 mm blind hole
Thread depth	T = 8.0 mm
Cutting speed Vc	30 m/min
Cooling/lubrication	CL outside

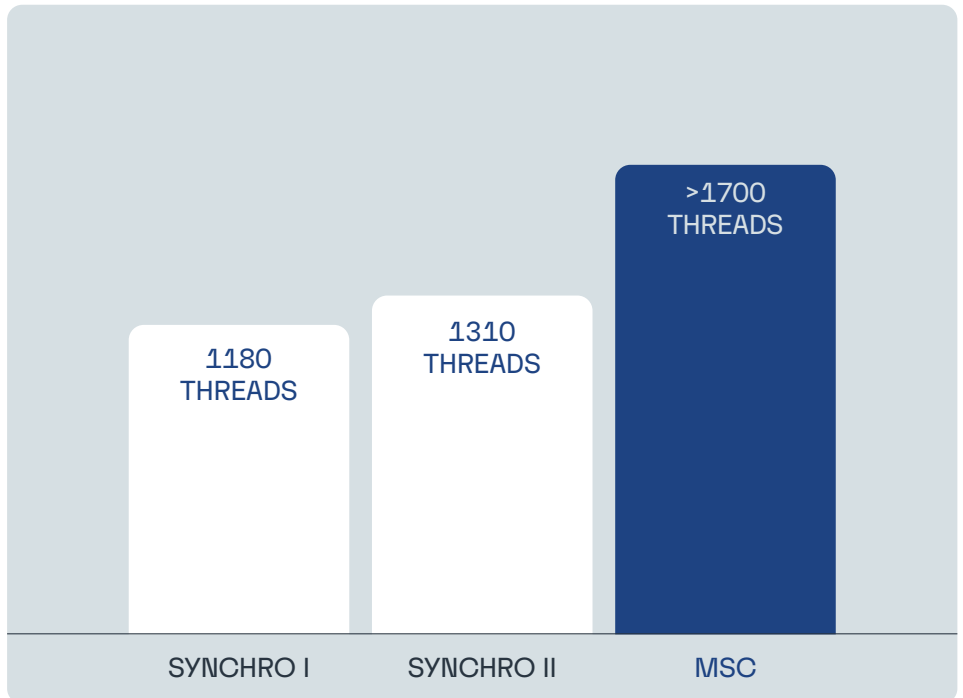

Process reliability: Automated 3-shift production

Machine	Heller FP4000
Machine interface	HSK-A 63
Material	3.2315 AlSi1MgMn
Thread size	M2.5 + M3
Speed	2000 1/min
Cutting speed Vc	19 m/min
Cooling/lubrication	CL inside + outside
Challenge	immersion depth

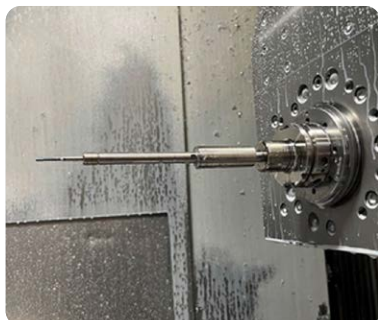

M2.5 and M3 thread forming (ACTUAL STATE BEFORE MSC USAGE:
unreliable process due to thread tool break)

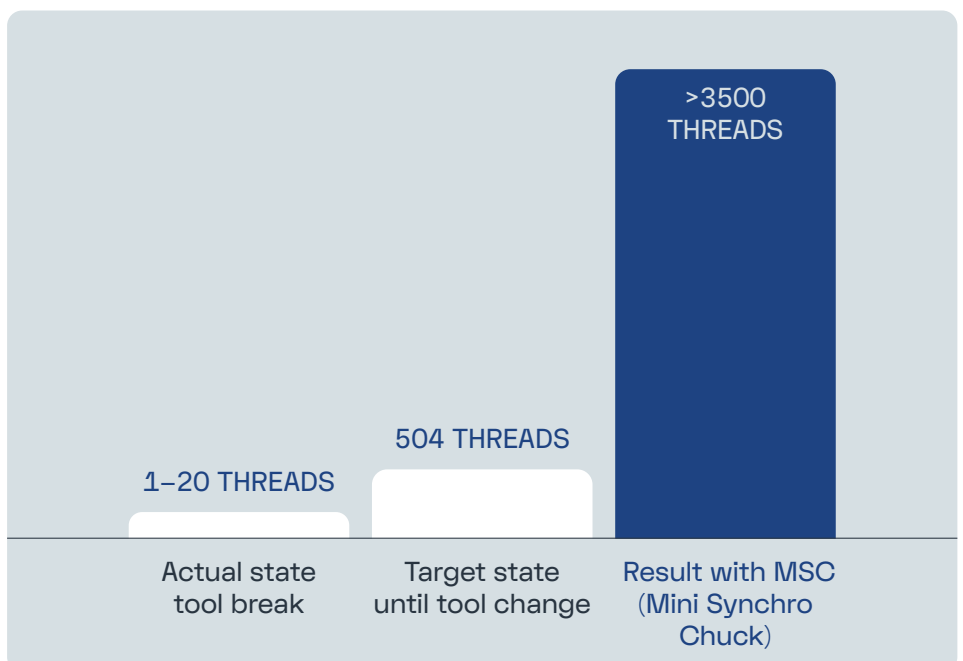

The CENTRO|P synchro product range at a glance



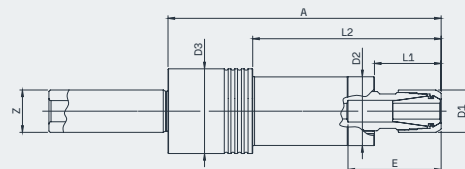
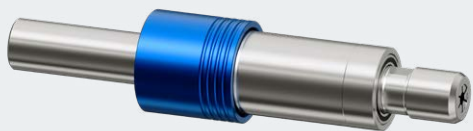

DESCRIPTION	ORDER-NO.	ER-SIZE	INTER-FACE		LENGTH		THREAD RANGE	D1 = WRENCH Ø	D2	D3	L1	L2	L3	E
					SHAFT	A-SIZE								
MSC8-Z10-A=83	53010340831	ER8	Z10	IC	18	83	M0,5 - M3	10	20	26	18	55	=A	25
MSC8-Z10-A=165	53010341651	ER8	Z10	IC	100	165	M0,5 - M3	10	20	26	100	137	=A	25
MSC8-Z10-A=215	53010342151	ER8	Z10	IC	150	215	M0,5 - M3	10	20	26	150	187	=A	25
MSC11-Z16-A=103	53031341031	ER11	Z16	IC	25	103	M3 - M6	16	26	32	25	71	=A	35
MSC11-Z16-A=228	53031342281	ER11	Z16	IC	150	228	M3 - M6	16	26	32	150	196	=A	35
MSC11-Z16-A=278	53031342781	ER11	Z16	IC	200	278	M3 - M6	16	26	32	200	246	=A	35
DSC16-Z16-A=116	55033301161	ER16	Z16	IC	34	116	M5 - M8	30	34	40	34	84	=A	37

SK (ISO 7388-1 Form AD)

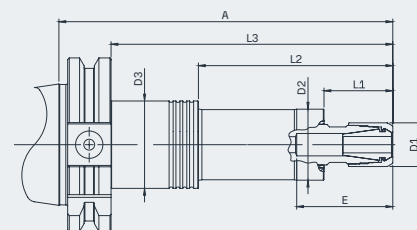

DESCRIPTION	ORDER-NO.	ER-SIZE	INTER-FACE		LENGTH		THREAD RANGE	D1 = WRENCH Ø	D2	D3	L1	L2	L3	E
					SHAFT	A-SIZE								
MSC11-AD40-A=122	53141341221	ER11	SK40	IC	25	122	M3 - M6	16	26	32	25	71	103	35
MSC11-AD40-A=247	53141342471	ER11	SK40	IC	150	247	M3 - M6	16	26	32	150	196	228	35
MSC11-AD40-A=297	53141342971	ER11	SK40	IC	200	297	M3 - M6	16	26	32	200	246	278	35
DSC16-AD40-A=135	55143301351	ER16	SK40	IC	34	135	M5 - M8	30	34	40	34	84	116	37

BT (ISO 7388-2 Form JD)

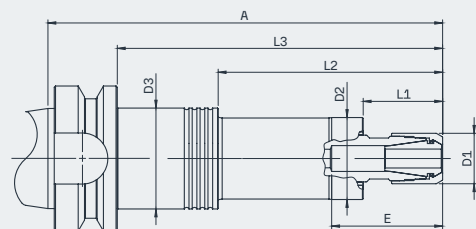
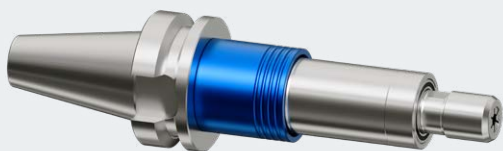

DESCRIPTION	ORDER-NO.	ER-SIZE	INTER-FACE		LENGTH		THREAD RANGE	D1 = WRENCH Ø	D2	D3	L1	L2	L3	E
					SHAFT	A-SIZE								
BT30														
MSC8-BT30-A=105	53420341051	ER8	BT30	IC	18	105	M0,5 - M3	10	20	26	18	55	83	25
MSC8-BT30-A=187	53420341871	ER8	BT30	IC	100	187	M0,5 - M3	10	20	26	100	137	165	25
MSC8-BT30-A=237	53420342371	ER8	BT30	IC	150	237	M0,5 - M3	10	20	26	150	187	215	25
MSC11-BT30-A=125	53421341251	ER11	BT30	IC	25	125	M3 - M6	16	26	32	25	71	103	35
MSC11-BT30-A=250	53421342501	ER11	BT30	IC	150	250	M3 - M6	16	26	32	150	196	228	35
MSC11-BT30-A=300	53421343001	ER11	BT30	IC	200	300	M3 - M6	16	26	32	200	246	278	35
DSC16-BT30-A=138	55423301381	ER16	BT30	IC	34	138	M5 - M8	30	34	40	34	84	116	37
BT40														
MSC11-BT40-A=130	53441341301	ER11	BT40	IC	25	130	M3 - M6	16	26	32	25	71	103	35
MSC11-BT40-A=255	53441342551	ER11	BT40	IC	150	255	M3 - M6	16	26	32	150	196	228	35
MSC11-BT40-A=305	53441343051	ER11	BT40	IC	200	305	M3 - M6	16	26	32	200	246	278	35
DSC16-BT40-A=143	55443301431	ER16	BT40	IC	34	143	M5 - M8	30	34	40	34	84	116	37

BTP (BT with Face Contact = similar to ISO 7388-2 Form JD)

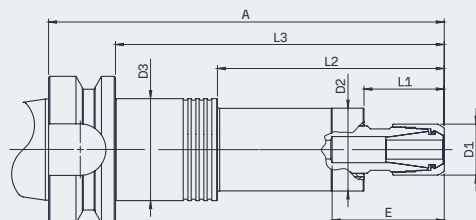
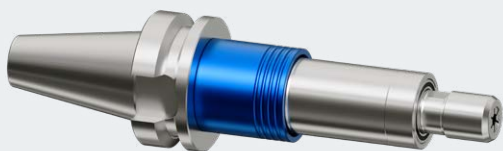

DESCRIPTION	ORDER-NO.	ER-SIZE	INTER-FACE		LENGTH		THREAD RANGE	D1 = WRENCH Ø	D2	D3	L1	L2	L3	E
					SHAFT	A-SIZE								
MSC8-BTP30-A=105	53430341051	ER8	BTP30	IC	18	105	M0,5 - M3	10	20	26	18	55	83	25
MSC8-BTP30-A=187	53430341871	ER8	BTP30	IC	100	187	M0,5 - M3	10	20	26	100	137	165	25
MSC8-BTP30-A=237	53430342371	ER8	BTP30	IC	150	237	M0,5 - M3	10	20	26	150	187	215	25
MSC11-BTP30-A=125	53431341251	ER11	BTP30	IC	25	125	M3 - M6	16	26	32	25	71	103	35
MSC11-BTP30-A=250	53431342501	ER11	BTP30	IC	150	250	M3 - M6	16	26	32	150	196	228	35
MSC11-BTP30-A=300	53431343001	ER11	BTP30	IC	200	300	M3 - M6	16	26	32	200	246	278	35

HSK-A (ISO 12164-1)

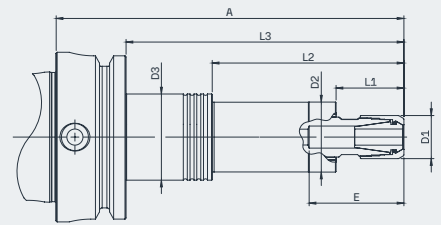

DESCRIPTION	ORDER-NO.	ER-SIZE	INTER-FACE		LENGTH		THREAD RANGE	D1 = WRENCH Ø	D2	D3	L1	L2	L3	E
					SHAFT	A-SIZE								
MSC8-HSK-A63-A=109	54160341091	ER8	HSK-A63	IC	18	109	M0,5 - M3	10	20	26	18	55	83	25
MSC8-HSK-A63-A=191	54160341911	ER8	HSK-A63	IC	100	191	M0,5 - M3	10	20	26	100	137	165	25
MSC8-HSK-A63-A=241	54160342411	ER8	HSK-A63	IC	150	241	M0,5 - M3	10	20	26	150	187	215	25
MSC11-HSK-A63-A=129	54161341291	ER11	HSK-A63	IC	25	129	M3 - M6	16	26	32	25	71	103	35
MSC11-HSK-A63-A=254	54161342541	ER11	HSK-A63	IC	150	254	M3 - M6	16	26	32	150	196	228	35
MSC11-HSK-A63-A=304	54161343041	ER11	HSK-A63	IC	200	304	M3 - M6	16	26	32	200	246	278	35
DSC16-HSK-A63-A=142	56163301421	ER16	HSK-A63	IC	34	142	M5 - M8	30	34	40	34	84	116	37

Suitable FAHRION collets at a glance

Version DIN ISO 15488-B

FOR MSC8

HIGH-PRECISION COLLETS GERC8-HP

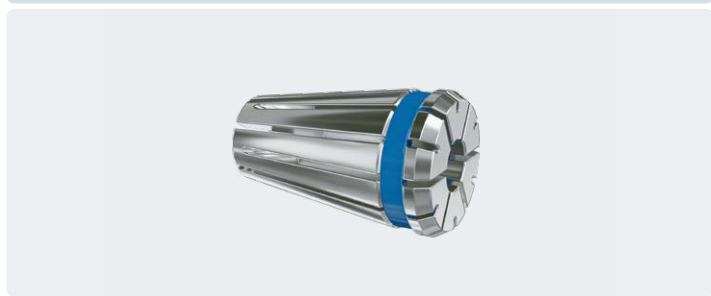

GERC8-HP Ø 1-5 MM

STANDARD

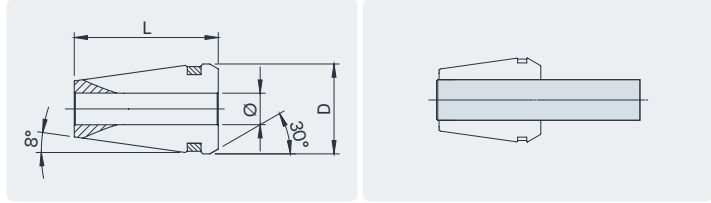

□ =	5 µm
D =	8,5 mm
L =	13,6 mm

Tool shank clamping tolerance h9

Ø mm	ORDER-NO.	Ø inch	ORDER-NO.
1,0	13610010100	1/16"	13610040159
1,5	13610010150	1/8"	13610040318
2,0	13610010200	3/16"	13610040476
2,5	13610010250		
2,8	13610010280		
3,0	13610010300		
3,5	13610010350		
4,0	13610010400		
4,5	13610010450		
5,0	13610010500		

FOR MSC11

HIGH-PRECISION COLLETS GERC11-HP



GERC11-HP Ø 1-7 MM

STANDARD

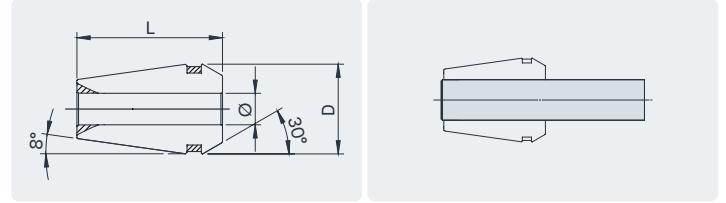

□ =	2 µm
D =	11,3 mm
L =	18,0 mm

Tool shank clamping tolerance h9

Ø mm	ORDER-NO.	Ø inch	ORDER-NO.
1,0	13611010100	1/16"	13611040159
1,5	13611010150	3/32"	13611040238
2,0	13611010200	1/8"	13611040318
2,5	13611010250	5/32"	13611040397
2,8	13611010280	3/16"	13611040476
3,0	13611010300	7/32"	13611040556
3,5	13611010350	1/4"	13611040635
4,0	13611010400		
4,5	13611010450		
5,0	13611010500		
5,5	13611010550		
6,0	13611010600		
6,5	13611010650		
7,0	13611010700		

FOR MSC11

HIGH-PRECISION COLLETS GERC11-HPD



GERC11-HPD Ø 3-6 MM

SEALED FOR INNER COOLANT SUPPLY

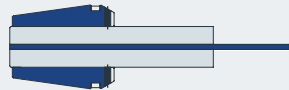
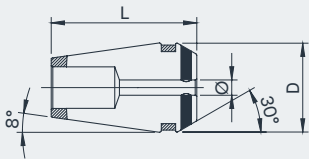

□ = 2 µm

D = 11,2 mm

L = 18,0 mm

Tool shank clamping tolerance

h9

Ø mm	ORDER-NO.	Ø inch	ORDER-NO.
3,0	13621010300	1/8"	13621040318
4,0	13621010400	3/16"	13621040476
5,0	13621010500	1/4"	13621040635
6,0	13621010600		

HIGH-PRECISION COLLETS GERC11-HPDD



GERC11-HPDD Ø 3-6 MM

SEALED FOR INNER COOLANT SUPPLY WITH JET HOLES

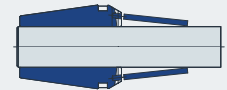
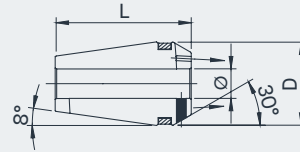

□ = 2 µm

D = 11,2 mm

L = 18,0 mm

Tool shank clamping tolerance

h9

Ø mm	ORDER-NO.	Ø inch	ORDER-NO.
3,0	13631010300	1/8"	13631040318
4,0	13631010400	3/16"	13631040476
6,0	13631010600	1/4"	13631040635

FOR MSC11 (WITH SQUARE DRIVE)

TAP COLLETS GERC11-GBD



GERC11-GBD Ø 2,8-6 MM

SEALED FOR INNER COOLANT SUPPLY

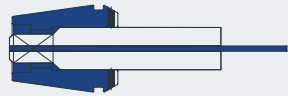
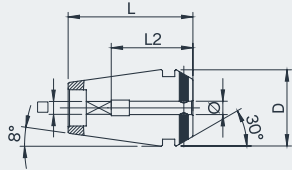

□ = 10 µm

D = 11,2 mm

L = 18,0 mm

Tool shank clamping tolerance h9

Ø/□ mm	L2	ORDER-NO.
2,8/2,1	12	13822010280
3,5/2,7	14	13822010350
4,0/3,2	14	13822010400
4,5/3,55	14	13822010450
6,0/5,0	14	13822010600

TAP COLLETS GERC11-GBDD



GERC11-GBDD Ø 2,8-6 MM

SEALED FOR INNER COOLANT SUPPLY WITH JET HOLES

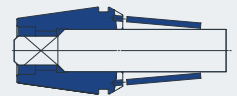
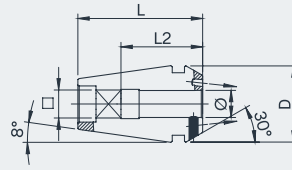

□ = 10 µm

D = 11,2 mm

L = 18,0 mm

Tool shank clamping tolerance h9

Ø/□ mm	L2	ORDER-NO.
2,8/2,1	12	13832010280
3,5/2,7	14	13832010350
4,0/3,2	14	13832010400
4,5/3,55	14	13832010450
6,0/5,0	14	13832010600

FOR DSC16

HIGH-PRECISION COLLETS GERC16-HP



GERC16-HP Ø 1-10 MM

STANDARD

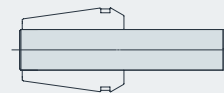
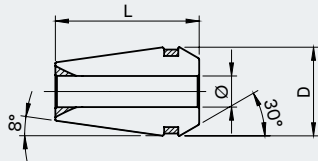

□ =	2 µm
D =	17,0 mm
L =	27,5 mm

Tool shank clamping tolerance

h9

Ø mm	ORDER-NO.	Ø mm	ORDER-NO.	Ø mm	ORDER-NO.	Ø inch	ORDER-NO.
1,0	13613010100	2,8	13613010280	6,5	13613010650	1/16"	13613040159
1,1	13613010110	2,9	13613010290	7,0	13613010700	3/32"	13613040238
1,2	13613010120	3,0	13613010300	7,1	13613010710	1/8"	13613040318
1,3	13613010130	3,1	13613010310	7,5	13613010750	5/32"	13613040397
1,4	13613010140	3,2	13613010320	8,0	13613010800	3/16"	13613040476
1,5	13613010150	3,3	13613010330	8,5	13613010850	7/32"	13613040556
1,6	13613010160	3,4	13613010340	9,0	13613010900	1/4"	13613040635
1,7	13613010170	3,5	13613010350	9,5	13613010950	9/32"	13613040714
1,8	13613010180	3,6	13613010360	10,0	13613011000	5/16"	13613040794
1,9	13613010190	3,7	13613010370			11/32"	13613040873
2,0	13613010200	3,8	13613010380			3/8"	13613040953
2,1	13613010210	4,0	13613010400				
2,2	13613010220	4,5	13613010450				
2,3	13613010230	5,0	13613010500				
2,4	13613010240	5,5	13613010550				
2,5	13613010250	5,6	13613010560				
2,6	13613010260	6,0	13613010600				
2,7	13613010270	6,3	13613010630				

FOR DSC16

HIGH-PRECISION COLLETS GERC16-HPD



GERC16-HPD Ø 3-10 MM

SEALED FOR INNER COOLANT SUPPLY

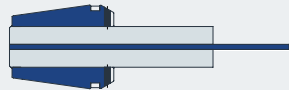
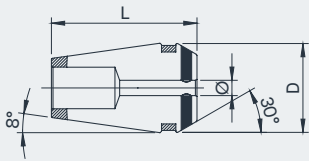

□ = 2 µm

D = 17,0 mm

L = 27,5 mm

Tool shank clamping tolerance

h9

Ø mm	ORDER-NO.	Ø inch	ORDER-NO.
3,0	13623010300	1/8"	13623040318
4,0	13623010400	5/32"	13623040397
5,0	13623010500	3/16"	13623040476
6,0	13623010600	7/32"	13623040556
7,0	13623010700	1/4"	13623040635
8,0	13623010800	9/32"	13623040714
9,0	13623010900	5/16"	13623040794
10,0	13623011000	11/32"	13623040873
		3/8"	13623040953
		13/32"	13623041032

HIGH-PRECISION COLLETS GERC16-HPDD



GERC16-HPDD Ø 3-10 MM

SEALED FOR INNER COOLANT SUPPLY WITH JET HOLES

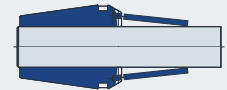
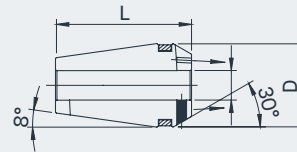

□ = 2 µm

D = 17,0 mm

L = 27,5 mm

Tool shank clamping tolerance

h9

Ø mm	ORDER-NO.	Ø inch	ORDER-NO.
3,0	13633010300	1/8"	13633040318
4,0	13633010400	3/16"	13633040476
6,0	13633010600	1/4"	13633040635
8,0	13633010800	5/16"	13633040794
10,0	13633011000	3/8"	13633040953

FOR DSC16 (WITH SQUARE DRIVE)

TAP COLLETS GERC16-GBD



GERC16-GBD Ø 2,8-9 MM

SEALED FOR INNER COOLANT SUPPLY

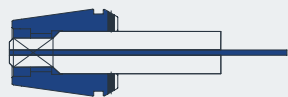
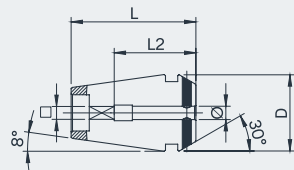

□ =	10 µm
D =	17,0 mm
L =	27,5 mm

Ø/□ mm	L2	ORDER-NO.
2,8/2,1	18	13823010280
3,5/2,7	18	13823010350
4,0/3,2	18	13823010400
4,5/3,55	18	13823010450
5,0/4,0	18	13823010500
5,5/4,5	18	13823010550
6,0/5,0	18	13823010600
6,3/5,0	18	13823010630
7,0/5,6	18	13823010700
7,1/5,6	18	13823010710
8,0/6,3	22	13823010800
9,0/7,1	22	13823010900

TAP COLLETS GERC16-GBDD



GERC16-GBDD Ø 3,5-9 MM

SEALED FOR INNER COOLANT SUPPLY WITH JET HOLES

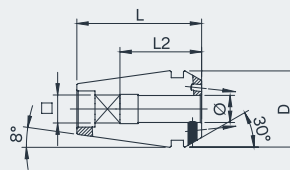

□ =	10 µm
D =	17,0 mm
L =	27,5 mm

Ø/□ mm	L2	ORDER-NO.
3,5/2,7	18	13833010350
4,5/3,55	18	13833010450
6,0/5,0	18	13833010600
7,0/5,6	18	13833010700
8,0/6,3	22	13833010800
9,0/7,1	22	13833010900

Have we convinced you?

Benefit now and make your
threading process more
reliable or increase the
service life of your tools.

CONTACT



Febametal S.p.A.

Via A.Grandi 15, 10095

Grugliasco (TO) Italia

011-7701412

febametal@febametal.com

www.febametal.com